

OPERATION

- Lever style handle with temperature indicator on the escutcheon
- Handle operates upward through a 23° arc. The rotation angle of temperature is 100°. Maximum hot through 50° in clockwise direction. Minimum cold through 50° in counterclockwise
- Adjustable temperature limit stop to control maximum hot water temperature
- Pressure balancing mechanism maintains selected discharge temperature to $\pm 3.6^{\circ}\text{F} (\pm 2^{\circ}\text{C})$

FLOW

- Showerhead is limited to 2.5gpm(9.5L/min) at 80psi
- Bathtub spout is minimum to 2.4gpm(9.0L/min) at 20psi

CARTRIDGE

- Pressure Balance cartridge

STANDARDS

- Third party certified to meet ASME A112.18.1 all applicable requirements referenced therein
- **ADA**  for lever handle

Specifications

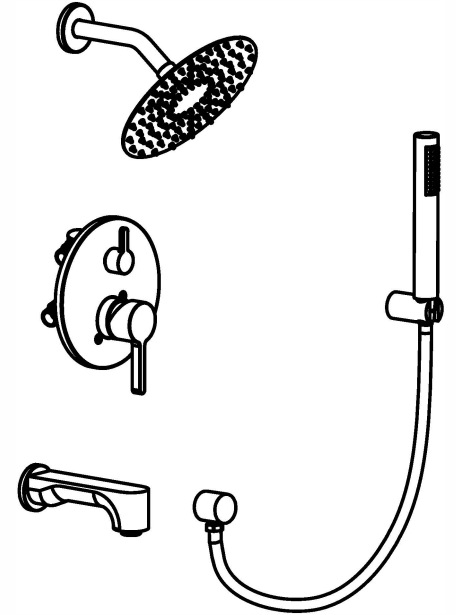

Three Function Concealed Shower Set

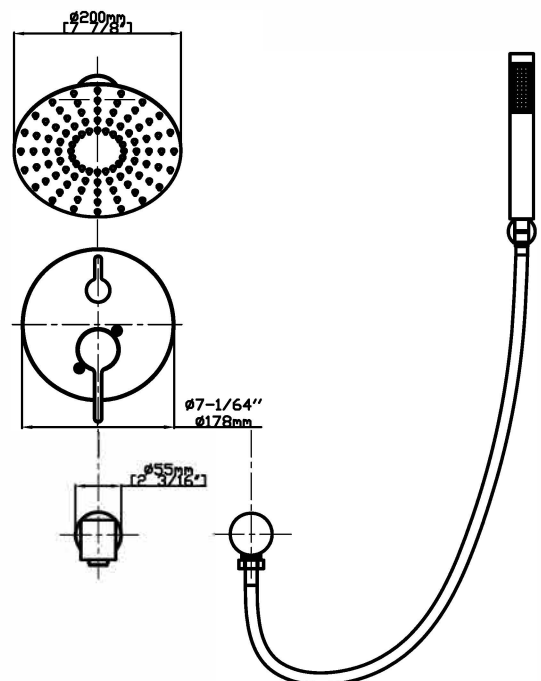
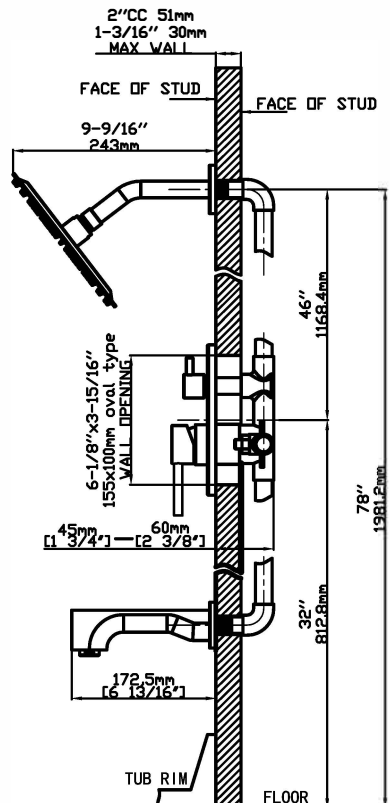
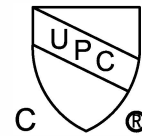

CRITICAL DIMENSIONS

Three Function Concealed Shower Set Installation

INSTALLATION MANUAL Tools You Will Need :

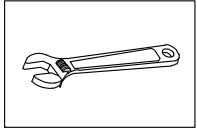

Adjustable wrench

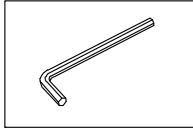

Hexagon wrench

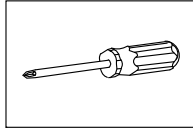

Phillips Screwdriver

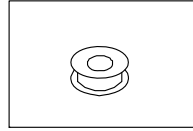

Pipe Tape

Notes before installation :

1. Please check that all components are present.
2. Before installation ensure that all feed lines are clear of debris and on/off valve is present.
3. Ensure water pressure is between 20-125 PSI (includes combination of hot and cold feed lines).
4. Pictures in the manual are general in content and may not represent exactly your purchased faucet. If you are having difficulties please contact a professional plumber.
5. If you will be away from home for an extended period you should shut off the main water supply.

⚠ All valves pass air and water testing during manufacture. If request air test before installation, MUST under the guide of professional plumber, and air pressure DO NOT over 145PSI (=10KG).

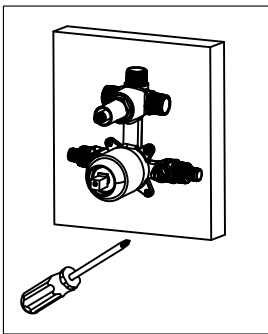

1. Confirm the installed place of the pressure balance valve and fixed on the wood block .

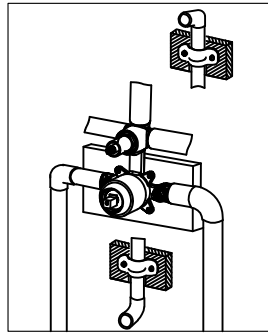

2. Connect the hot&cold inlet tube and outlet tube, then make sure the tube fix stable on the wooden wall.

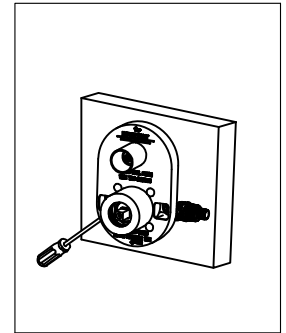

3. Lock the install protective cover into the body. (155*100mm oval type).

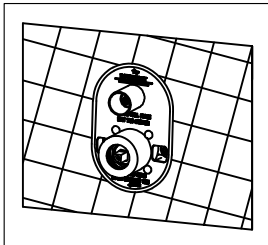

4. Please cut the size of the tile hole according to the size and shape of the protected cover (about 5mm bigger than the protected cover from each side) . And please put the tile outside the wooden wall (please noted that we keep the same central point for the tile hole with the protected cover) .

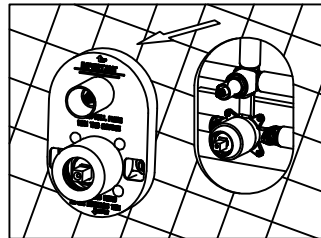

5. Loosen the screw and remove protect cover.

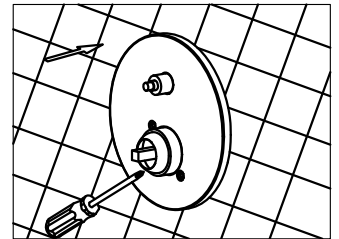

6. Lock the deck plate into the body and cling to the wall, then tight the screw.

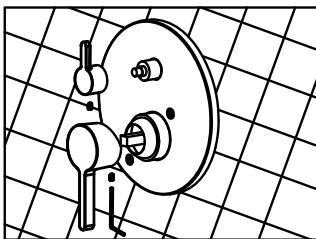

7. Put on the handle, then tight the screw.

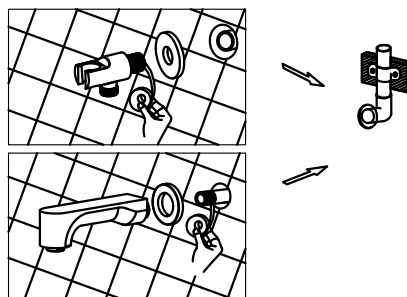

8. Wrap the thread of spout with teflon tape (ensure it must wrap clockwise). Screw-in to the inlet pipe inside the wall, then install the decorative cover on the wall clingy.

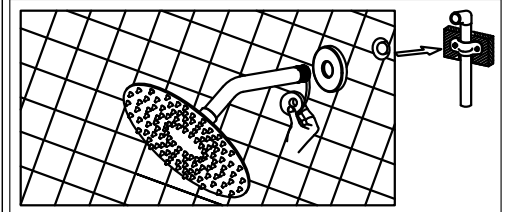

9. Install the shower arm, shower head and flange to the fitting. (stick to the wall) . Tighten the showerhead to the shower arm with the pipe tape. (Make sure the pipe tape with clockwise direction) .