

FVN2248 KINGSTON INSTALLATION GUIDE

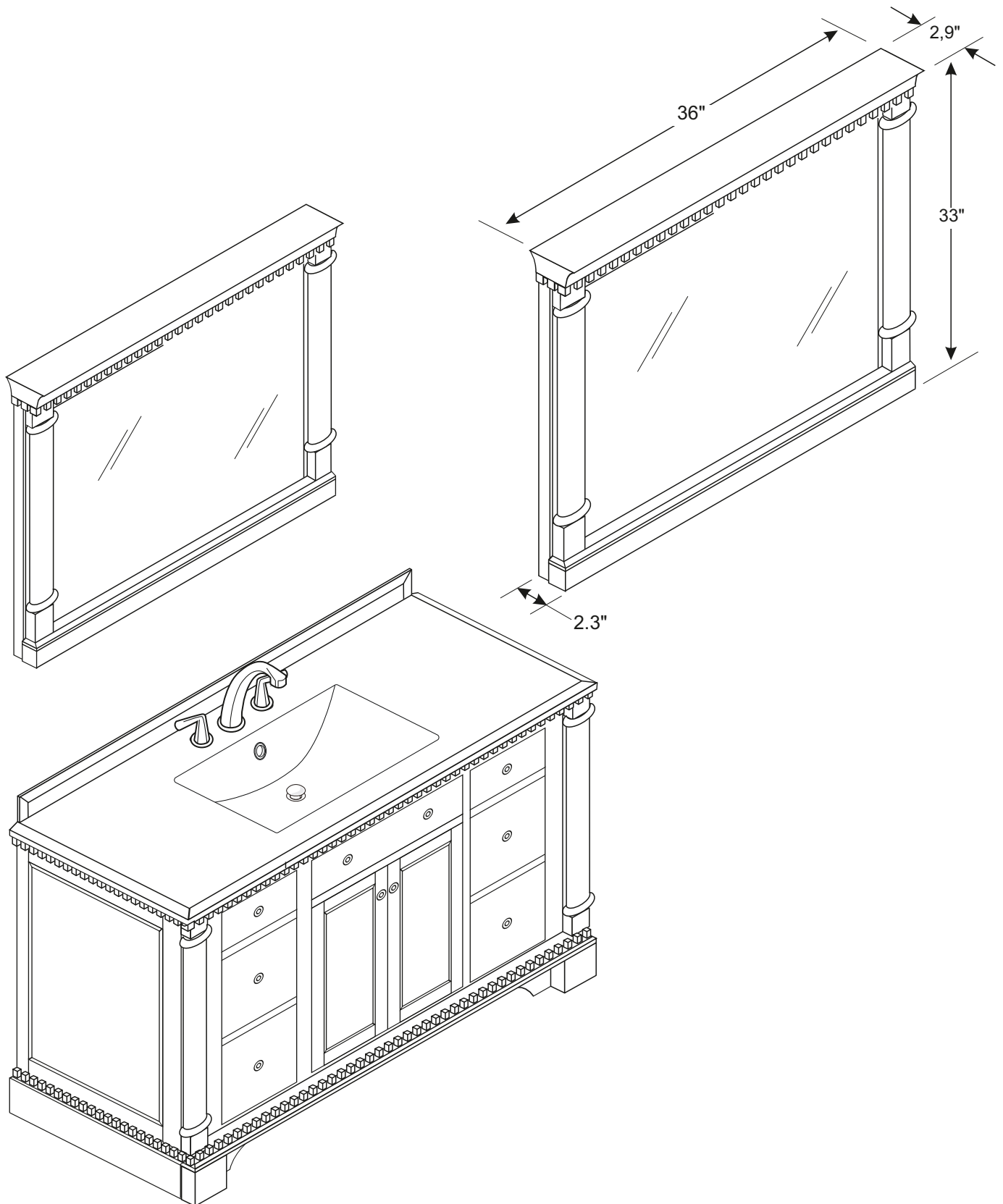

Note: All dimensions and specifications are approximate and subject to change without notice.

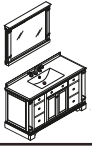

FVN2248 KINGSTON INSTALLATION GUIDE



Vanity Front

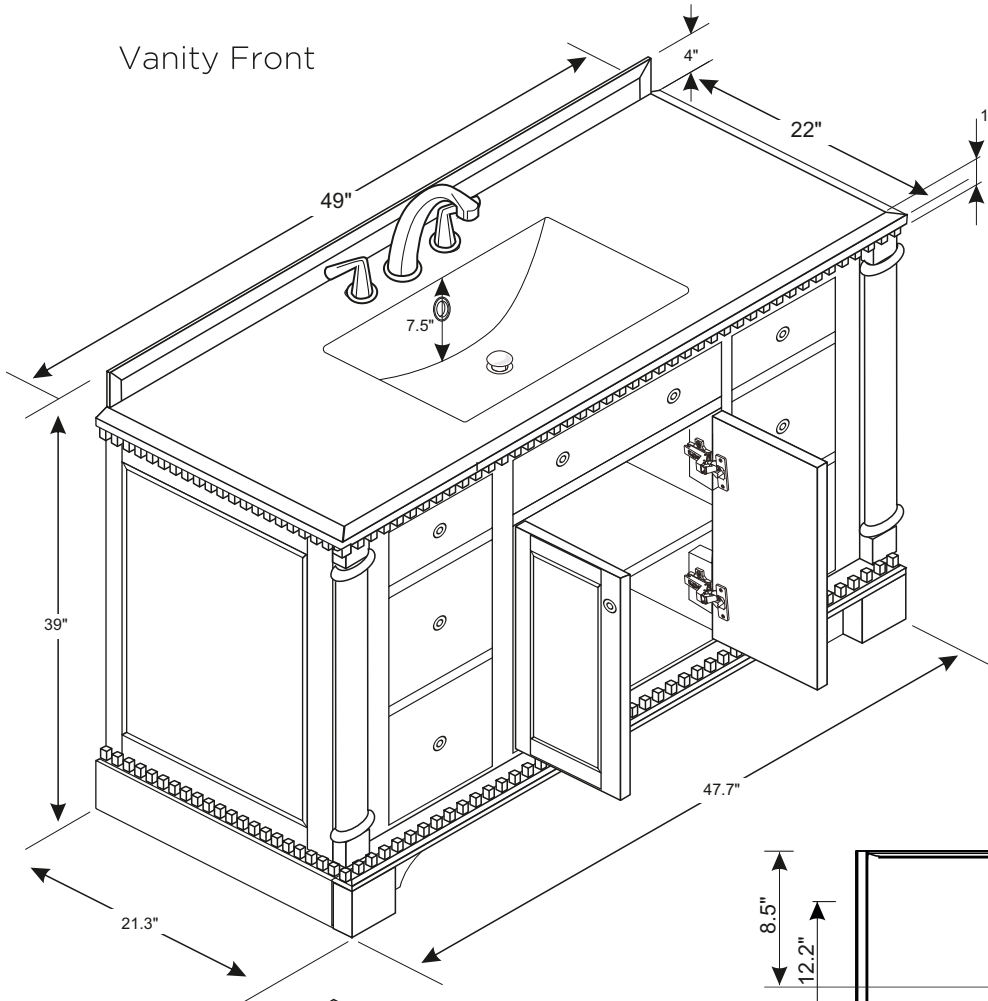

Vanity Back

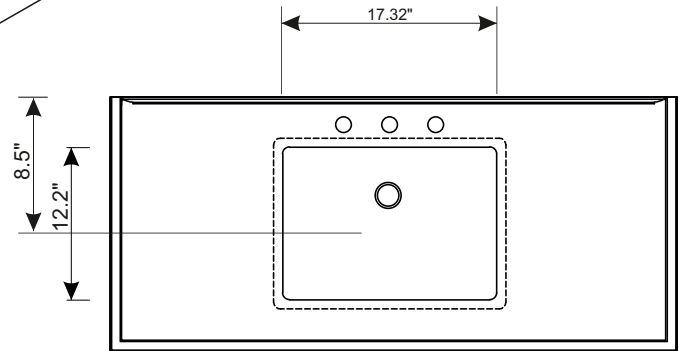
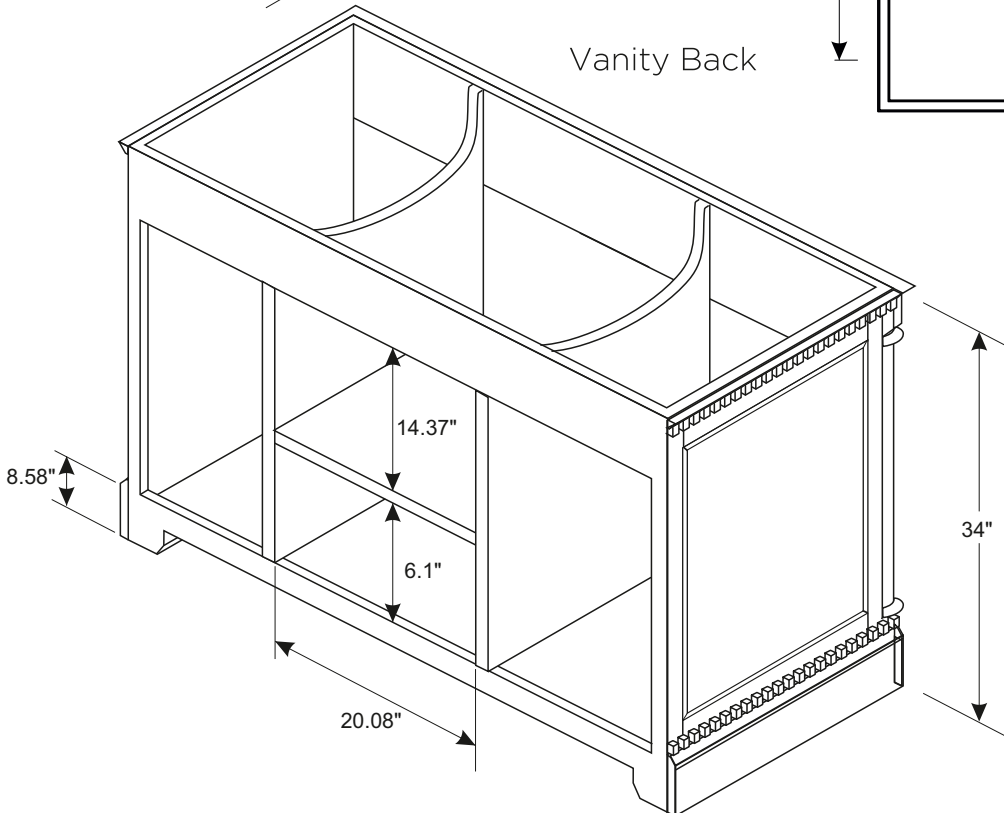

MIRROR INSTALLATION INSTRUCTIONS

- 1 Flip the mirror over and measure the distance between the holes.

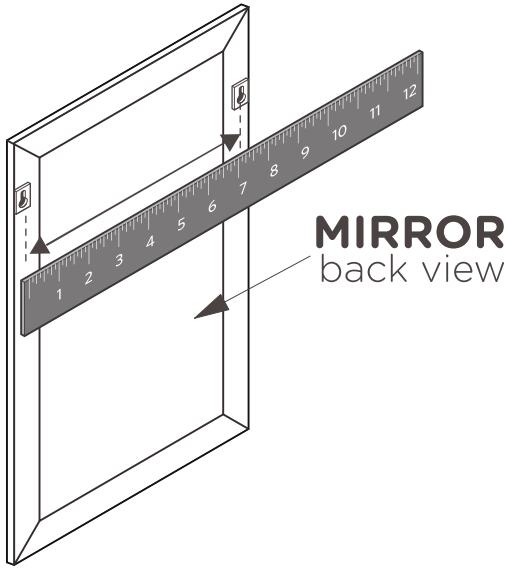

TOOLS FOR ASSEMBLY

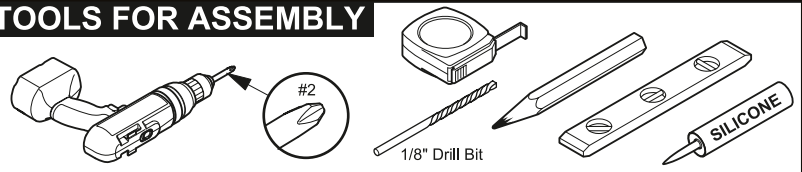

- 2 Mark the measured distance on the wall using a level.

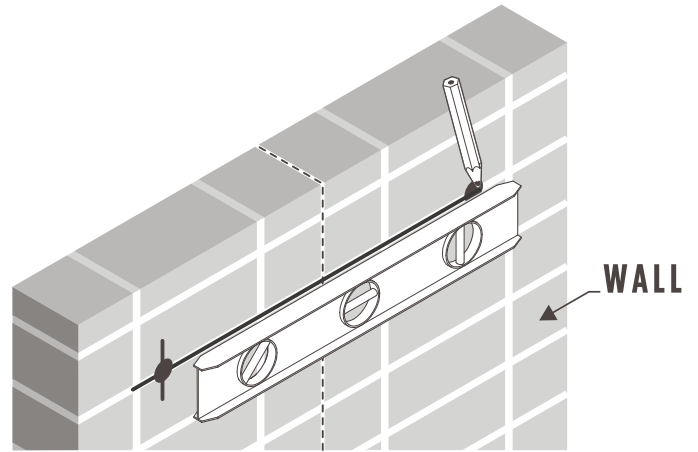

- 3 Once positions is marked drill 2 holes and insert anchors if stud is not available.

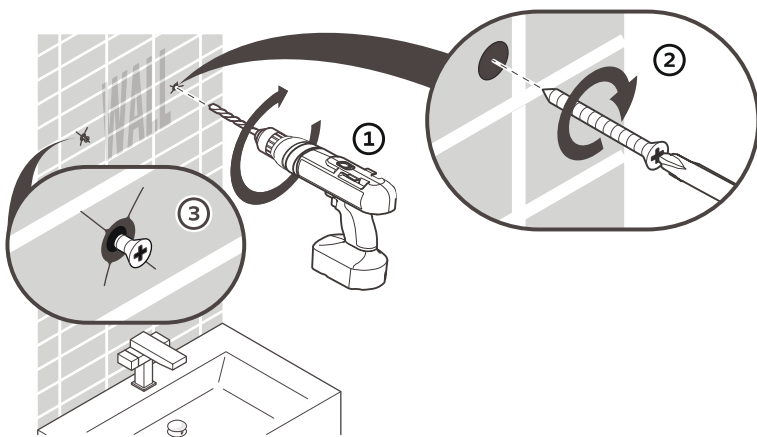

- 4 Hang mirror on the wall.

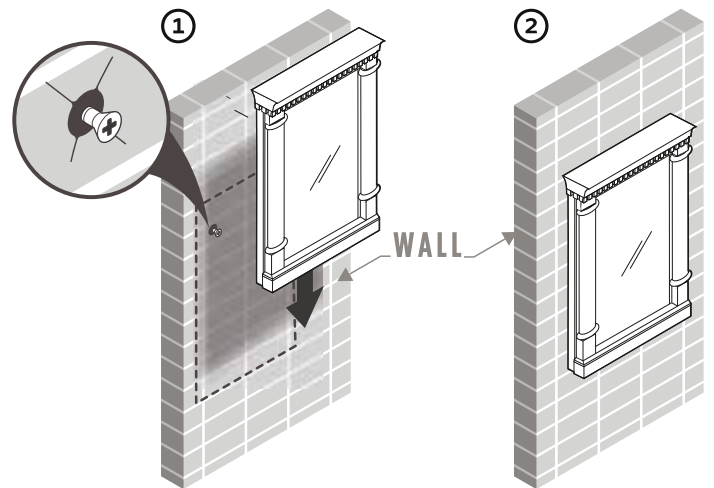

IMPORTANT:

CONSULT AN EXPERT FOR THE PROPER SCREWS/BOLTS TO USE WHEN ATTACHING TO VARIOUS WALL CONSTRUCTIONS. SCREWS PROVIDED **DO NOT ATTACH** TO ALL WALL CONSTRUCTION TYPES.



1 Remove side cabinet drawer.

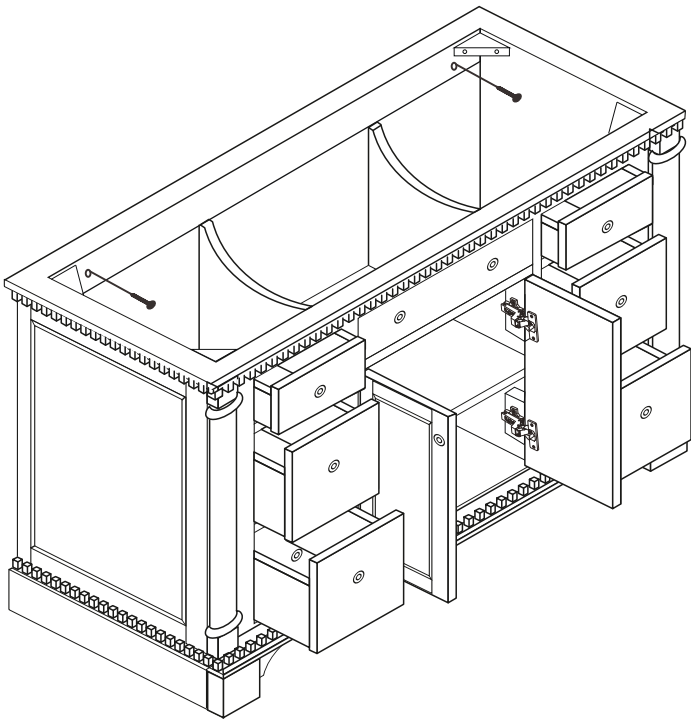

IMPORTANT: Consult an expert for the proper screws/bolts to use when attaching to various wall constructions. Screws provided do not attach to all wall construction types.

2 Apply a bead of silicon on the top of the cabinet and place the sink on top.

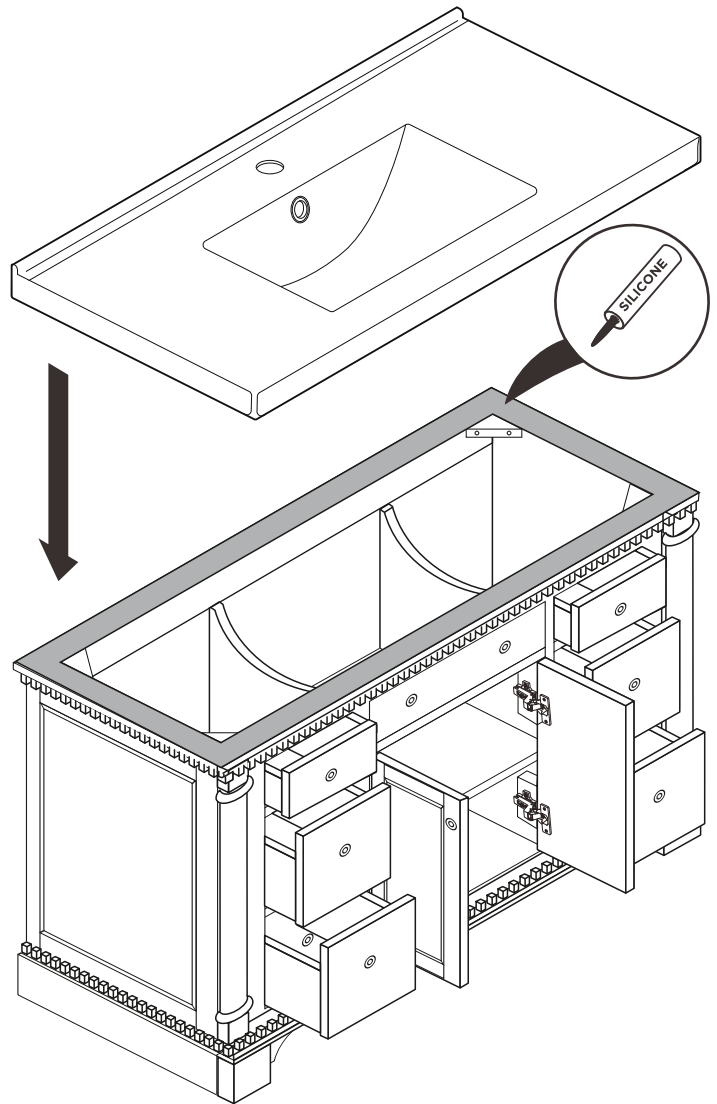

REMOVAL

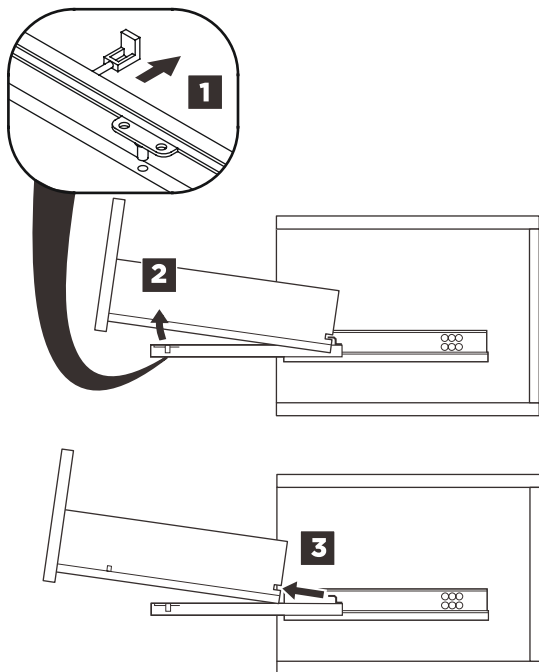

INSTALLATION

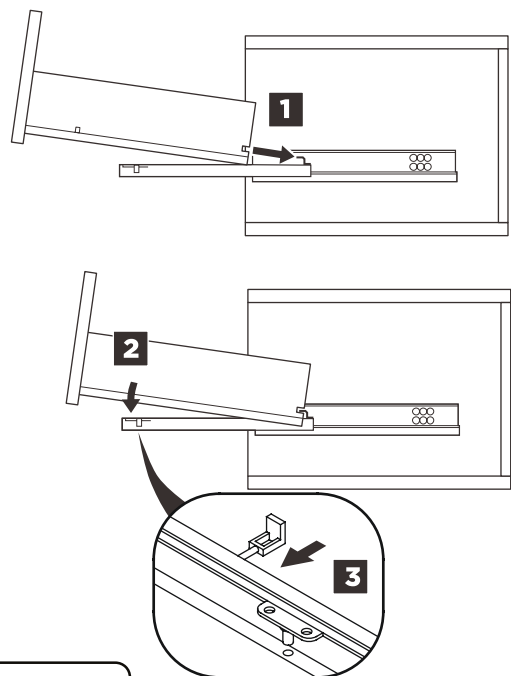

P-TRAP AND POP-UP INSTALLATION INSTRUCTIONS

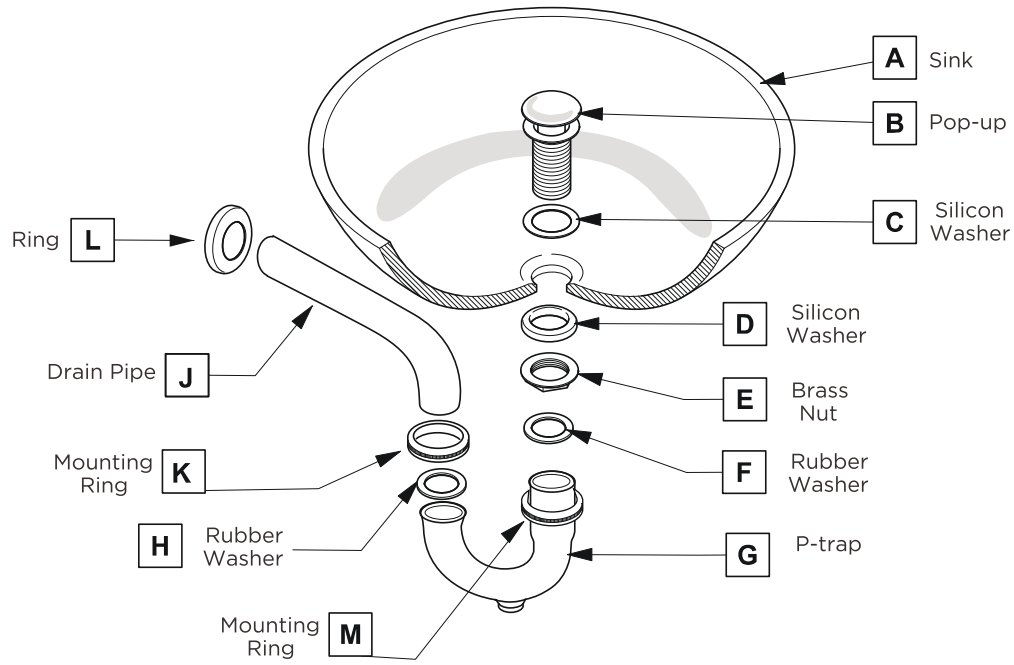

POP-UP INSTALLATION

FOR SINKS WITHOUT OVERFLOW

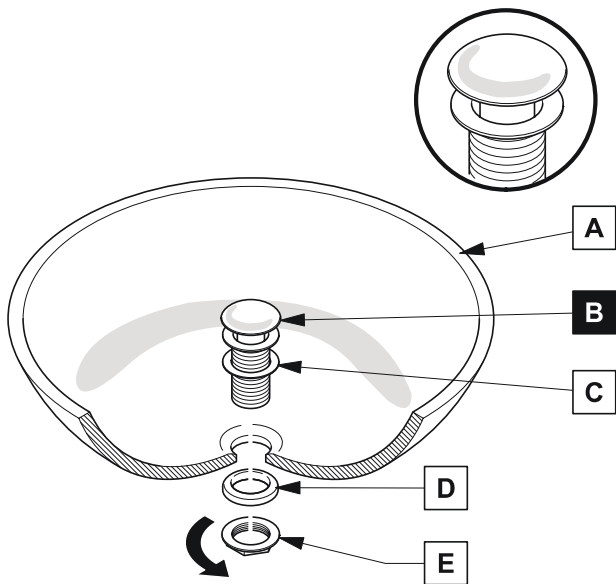

OR

FOR SINKS WITH OVERFLOW

